

SR-112

Time Code Distripalyzer

Owner's manual

Version 4.01
October 2016

All materials herein © Brainstorm Electronics, Inc.

Brainstorm Electronics reserves the right to change or modify the contents of this manual at any time.

Credits

Concept: AID, Brainstorm Electronics
Software: Gerry Lester
Manual: Bernard Frings, Gerry Lester
Technical Assistance: Jim Pace

Table of contents

1. INTRODUCTION	3
2. INSTALLATION	3
3. I/O'S DESCRIPTION AND CABLE REQUIREMENTS	4
4. QUICK START	5
5. FRONT PANEL DISPLAY & LED'S	5
LCD Display	5
Time Code Reader	6
Generator LED's	6
Status LED's	6
Warning LED's	6
Power LED's	7
6. SET UP, NAVIGATION & ENTER KEYS	7
7. MENU NAVIGATION	8
8. MENUS DESCRIPTION	9
01- Mode	9
02- Output Rise Time	9
03- Output Levels (menus 03-05)	9
06- Beeper	9
07- Video Phase Threshold	9
08- Video Drift Threshold	10
09- Alternate Phase with 50 & 60 Hz Video	10
10- Time Code Generator (menus 10-29 reserved for TCG option)	10
91- Ethernet (Menus 91-94 used for Ethernet settings)	10
98- Feature Key	10
99- SR-112 Software version & Serial No	11
9. RESHAPING AND DISTRIBUTING TIME CODE	11
Time Code Distribution	11
Reshaping Distorted Time Code	11
Time Code Level	11
Selecting The Proper Rise Time	11
10. TIME CODE ANALYZER	12
Format and Frame Rate	12
Video Phase	13
Reporting Time Code Errors	14
Power-Up Error Blackout	15
Reset	15
11. NON-VOLATILE STORAGE	16
12. ETHERNET	16
Ethernet IP Settings	16
Main HTML Page	16
13. FIRMWARE UPDATES	18
Programming Sequence	18
Programming Errors	19
Loader	19
Complete vs, Software Firmware Updates	20
14. USER BITS	21
15. APPENDIX	22
A. Video formats supported by the SR-112	22
B. Pinout Diagram for D25 connector	22
C. Time Code Error Messages	23
D. Longitudinal Bit Assignment: SMPTE and EBU	24

1. Introduction

Congratulations on purchasing the SR-112 Time Code Distripalyzer. The SR-112 combines several functions in one unit including most of the functions of the Brainstorm SR-15+ and, with the TCG option installed, of the SR-3.

- The Distributor reshapes time code and distributes it through its 12 individually buffered outputs;
- The Analyzer identifies the type, the stability and the frame rate of the incoming time code; it verifies its proper synchronization (phase) with video; and it reports time code errors (drop outs...)
- The Generator (optional software) repairs damaged time code by jam-syncing and generates new time code genlocked to video or not
- The Ethernet port lets you connect to the SR-112 using standard TCP/IP protocol to access the unit remotely and to update its firmware.

2. Installation

2.1. UNPACKING

When unpacking your SR-112 the following items should be in the shipping carton:

- SR-112 unit
- Universal Power Supply (12VDC @ 16w)
- IEC power cable
- Owner's Manual & Registration card

2.2. INSTALLING THE SR-112

The SR-112 is designed to be mounted in a standard 19" rack. It requires 1U in height.

Usual precautions should be respected when wiring the SR-112: use high quality cables with good shield to guarantee a good signal transmission. Keep your cables as short as possible.

To preserve the integrity of the transmission line, it is recommended that you do not 'mult' a single output to multiple devices as it can degrade signal quality.

The video reference needs to be properly terminated. If the SR-112 is the last device in the chain, turn on the 75Ω termination switch on the rear panel. If you are looping through using a 'T' connector, turn off the termination switch and make sure there is a 75Ω termination at the end of the chain.

3. I/O's Description and Cable Requirements

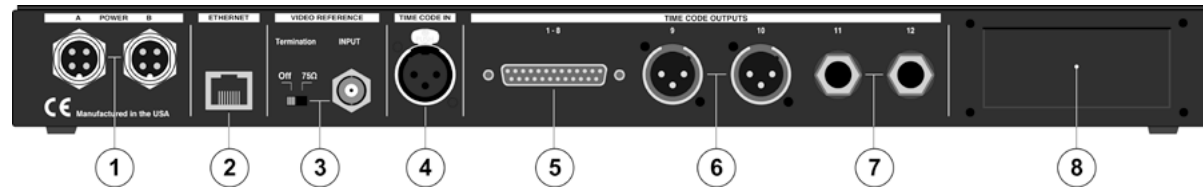

3.1 POWER

The SR-112 requires 12VDC @ 18W. Acceptable range is 12VDC +/-15%.

The external supply provided with the SR-112 accepts 100 to 240 VAC input at 50 - 60 Hz so it is suitable for use anywhere in the world.

Optionally, a second power supply can be connected to Power Input B for redundancy. To order a second power supply contact your dealer.

> Insert the 4 pin plug into the rear panel jack and secure by screwing the ring. Plug the supply into the wall using the standard IEC cable supplied.

3.2 ETHERNET

The Ethernet port is used to connect the SR-112 via TCP/IP protocol to access the unit remotely and to upload firmware from any computer on the network.

Connector: RJ45 jack

> Use a standard Ethernet cat5 cable with RJ45 plugs.

3.3 VIDEO REFERENCE INPUT & TERMINATION SWITCH

Input accepts HD and SD sync (see Appendix A for a list of supported formats). Switch enables 75Ω termination. Use when if SR-112 is at the end of the chain.

Connector: BNC

> Use a standard 75Ω BNC cable.

3.4 TIME CODE INPUT

Accepts any time code format at speeds ranging from 1/30x to 60x playspeed.

Connector: XLR female

> Use a standard audio cable, Pin #2 Hot. Balanced or unbalanced systems.

3.5 TIME CODE OUTPUTS 1-8

Connector: 25 pin D Female (See Appendix C for wiring diagram)

> Use standard Tascam/Avid (Digidesign) analog audio pin out configuration and if needed, a readily available DB-25 male to 8 XLR male break-out cable from third party companies.

3.6 TIME CODE OUTPUTS 9-10

Connector: XLR male (x2)

> Use standard audio cables, Pin #2 Hot. Balanced or unbalanced systems.

3.7 TIME CODE OUTPUTS 11-12

Connector: 1/4" stereo (x2)

> Use standard audio cables with a Tip/High, Ring/Lo, Sleeve/Ground configuration. Balanced or unbalanced systems.

3.8 SLOT FOR FUTURE OPTION CARDS

4. Quick Start

You should read this manual to familiarize yourself with the SR-112 features. The following simple steps are only provided to get you started right away.

NOTE: The SR-112 reshapes and distributes time code. With a software upgrade (TCG), it also repairs and generates time code. For instructions on those features, please refer to the TCG manual.

Connect the power supply to the Power A jack and plug the IEC cable into a wall outlet. Then tap the front panel power switch to turn on your unit (there will be a small delay, approx. 2 seconds, before the front panel actually turns on).

Connect your time code source to the XLR TC input and, if available, connect your video reference to the video input BNC. Out of the box, the SR-112 is set to reshape and distribute your time code source through its 12 outputs. Output levels are set to 0dBu.

5. Front Panel Displays & LED's

5.1. LCD DISPLAY - STATUS PAGES

The 32 characters LCD display has 5 different status pages: Time Code In, Video, User Bits, Video Phase and Errors.

To access these different pages, press the [UP] or [DOWN] key.

• TIME CODE IN

```

TC In Status
LTC 30DF 29.970
  
```

Displays the type of time code (bottom line, left), the format (bottom line, center) and the rate (bottom line, right).

Time Code formats are 30DF, 30ND, 25 and 24 f/s code.

The rate is displayed via a frequency counter with 3 decimals.

• VIDEO FORMAT

```

Video Format
1080P/23.976
  
```

Displays the format and the rate of the video reference.

See Appendix B for a list of supported video formats.

• USER BITS

```

User Bits In
8bit 55.53.45.52
  
```

Displays the User Bits and the User Bits type. See chapter 13 for more info.

• VIDEO PHASE

```

TC:Video Phase
-000.0°
  
```

Displays the phase between time code and the video reference by indicating the time code bit lined up with Video Sync. Ideally it should read '+000.0°'.

See 10.2 for more on video phase.

• TIME CODE ERRORS



Displays the last 50 time code errors since the last reset. The first line has a description of the error, the second the faulty time code address. To scroll through the different errors, press the [LEFT] and [RIGHT] keys.

The left/right arrows are only present when there are more errors in that direction. Right = increasing time codes; Left = decreasing.

The display normally shows the most recent error, but arrowing to the left will hold it at the error being viewed. It will return to displaying the most recent error if the operator either arrows all the way to the right, or switches to a different display and back (e.g. to the TC In Status display, or to a Menu).

For a complete list of errors see Appendix C.

5.2. TIME CODE READER (8 DIGIT NUMERIC DISPLAY)



The reader displays the incoming time code in hours, minutes, seconds and frames.

It also momentarily flashes an error description when errors are detected such as drop outs...

5.3. GENERATOR LED'S

Please refer to the TIME CODE GENERATOR manual (TCG) for information on these LED's.



5.4. STATUS LED'S

- The top 3 LED's indicate the selected operation mode: Reshape / Repair / Generate. Only one of these LED's can be on at a time.

Note: Repair and Generate are only available when the optional TCG software has been installed.

- The bottom 3 led's (TC In, Video In, Ethernet) light up when a valid signal is present at the corresponding port.

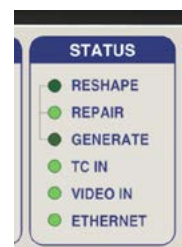

5.5. WARNING LED'S

- Input Error: Flashes to indicate an error was detected. To view this error, go to the ERROR page on the LCD display (see 5.1 above). To clear, press any key.
- Video Phase: Indicates that Video and Time Code are locked with an offset (out of phase). Go to 10.2 for more information on Video Phase.
- Video Drift: Indicates that Video and Time Code are not locked



- Video Term Off: Indicates that the 75Ω Video Termination has been switched off on the rear panel.

Termination should be switched on when the SR-112 is the last unit on the video line; when using a 'T' to loop through, it should be off.

5.6. POWER LED'S

When the SR-112 is turned on, the Power A and Power B LED's light up to indicate that power is present at the corresponding connector. When the SR-112 is turned off, these LED's stay off, even with power present at the connector.

When using 2 power supplies, if one fails, the corresponding LED will blink as a warning.

If that occurs, the faulty supply can be changed without powering down



6. Navigation Keys

6.1. SET UP KEY

The Set Up mode is used to change parameters.

To enter the Set Up mode, press the [SET UP] key.

While in Set Up mode, the SET UP LED is on.

To exit the Set Up mode, simply press the [SET UP] key again.

Note: Holding the [SET UP] key for 3 seconds or more will reset the SR-112 (see 10.5 for more on Reset).

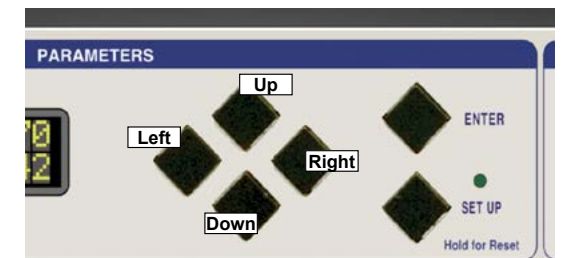

6.2. ENTER KEY

In SET UP mode, scrolling through the different values will not affect anything. Only after the [ENTER] key is pressed will a change take place.

When exiting a menu without pressing the [ENTER] key, the changes are lost.

6.3. UP, DOWN, LEFT, RIGHT KEYS

These 4 keys are directly right of the LCD display. They are not labeled as such because their function is fairly obvious.

The [LEFT] and [RIGHT] keys are used to move to a different field while the [UP] and [DOWN] keys are used to change a value.

The [UP] and [DOWN] keys are also used to move to another menu or page.

7. Menu Navigation

7.1. SELECTING A MENU

When entering the Set Up mode, the LCD display switches to the Set Up menu last used, with the cursor on the far left position in the upper line. The cursor position is indicated with a '>' character, implemented as inverse video, flashing on and off.

```
03 TC Gain 1-4
>12 12 12 12
```

To move to another menu, with the cursor on the upper left position, press the [UP] or [DOWN] key.

7.2. CHANGING VALUES

To edit one of the fields on the current menu, press the [RIGHT] or [LEFT] key to move the cursor to the desired field. Then, press the [UP] or [DOWN] key to change the value.

Note that no change will take effect until the [ENTER] key is pressed. When exiting a menu without pressing the [ENTER] key, the changes are lost.

7.3. THE CURSOR

The cursor position is indicated with a '>' character, implemented as inverse video, flashing on and off..

After a value is edited, the cursor changes to a solid triangle, until the [ENTER] key is pressed.

```
03 TC Gain 1-4
▶10 ▶10 >12 12
```

If the cursor is moved to another field without pressing the [ENTER] key first, the solid triangle stays in front of the edited field to indicate a change was made but not entered yet.

7.4. STATUS VALUES

Throughout the different menus, values appear in the display enclosed in square brackets. These are status values.

Status values are the values actually obtained, based on a menu selection such as the output rise time in menu 04.

```
04 TC Rise Time
>Square [1us]
```

8. Menu Description

8.1. MENU 01: MODE

```
01 Mode
>Reshape
```

The SR-112 has 3 different operating modes:

- Reshape
- Repair
- Generate

Note: Menu 01 only appears when the TCG software option has been installed since, without it, Reshape is the only mode available.

8.2. MENU 02: OUTPUT RISE TIME

```
02 TC Rise Time
>Square [1us]
```

Three different rise and fall times are available for the output waveform: 1 μ s is a square wave; 40 μ s is per SMPTE /EBU specifications; 20 μ s is an intermediate value. Menu 02 lets you select one of these 3 waveforms. This is a global selection for all 12 outputs.

See 9.4 for more on rise time.

8.3. MENUS 03-05: OUTPUT LEVELS

```
03 TC Gain 1-4
>12 12 12 12
```

These three different menus (03, 04, 05) are for adjusting the levels of the 12 outputs.

Levels go from full off to +12db (0 to 50 on the LCD). With a balanced output, 12 is approximately 0dbU; with unbalanced, 24 is.

NOTE: For menu 05, it is not necessary to hit the [ENTER] key. The changes take place instantly.

8.4. MENU 06: BEEPER

```
06 Beeper
>On
```

Menu 06 enables you to turn the beeper on or off.

8.5. MENU 07: VIDEO PHASE THRESHOLD

```
07 Phase Thresh
>20°
```

Menu 07 is for changing the threshold at which time code is considered out of phase with video (and lights up the Video Phase LED). See 10.2 for more info.

8.6. MENU 08: VIDEO DRIFT THRESHOLD

```
08 Drift Thresh
00.8%
```

This menu lets you adjust the threshold at which time code is considered drifting relative to video (and lights up the Video Drift LED). See 10.2 for more info.

8.7. MENU 09: ALTERNATE PHASE WITH 50&60Hz VIDEO

```
09 Vid 2x Phase
A [50-60Hz]
```

Menu 09 allows you to switch "A"/"B" phases when working with a 2x rate video input. For more information, see 10.3.

8.8. MENUS 10-29: TIME CODE GENERATOR

Menus 10 through 29 are assigned to the optional Time Code Generator and are only available if the TCG software has been installed.

For more information on these menus, please refer to the TCG manual.

8.9. MENUS 91-94: ETHERNET

```
91 DHCP
On
```

DHCP stands for Dynamic Host Configuration Protocol.

When the DHCP option is turned on, the DHCP server automatically assigns an IP address to the SR-112. It also assigns other IP configuration parameters, such as the subnet mask and the default gateway.

When DHCP is on, menus 92, 93 and 94 become status menus, displaying the IP Address, Mask and Gateway but not allowing you to change them.

If DHCP is off, then the IP address, mask and gateway need to be entered manually in menus 92, 93 and 94.

```
92 IP Address
192.168. 0.120
```

```
93 IP Mask
255.255.255. 0
```

```
94 IP Gateway
192.168. 0. 1
```

For more on Ethernet, go to chapter 10 page 16.

8.10. MENUS 98: FEATURE KEY

```
98 Feature Key
00.12.34.56
```

Menu 98 lets you enter a unique key to authorize certain features on your SR-112, such as the TCG.

8.11. MENU 99: SOFTWARE VERSION & SERIAL NUMBER

```
99 Ver: 1.00
S/N: 1234
```

This menu is status only and indicates the current firmware version and the unit's serial number.

IMPORTANT NOTE ON MENU OPERATION: Remember to always press the [ENTER] key to save your settings prior to exiting a menu or to exiting the SET UP mode. No change will take place until the [ENTER] key is pressed.

9. Reshaping and distributing time code

9.1. TIME CODE DISTRIBUTION

Simply muting a time code source can cause serious problems and is not recommended. The SR-112 eliminates these potential problems by providing 12 individually buffered and balanced outputs.

9.2. RESHAPING DISTORTED TIME CODE

On older analog tape machines (especially VTR's), time code usually has improper rise/fall times, leading edge peaking and different amplitude levels on "one's" and "zero's" (see diagrams below). This is due to the fact that analog tape machines were not designed to record a signal that is basically digital.

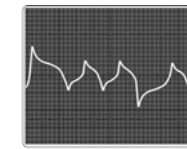

Analog tape machine
Play Speed

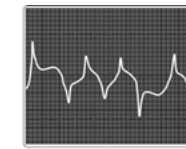

Analog tape machine
High Speed

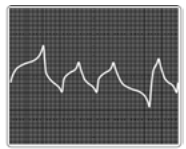

Analog tape machine
Low Speed

As a result, time code could become unreadable.

The SR-112 eliminates these amplitude distortions by reshaping the code to its original SMPTE or EBU specifications.

9.3. TIME CODE LEVEL

Level fluctuations or improper level can also render time code unreadable.

With the SR-112, each output level is individually adjustable so that optimum levels can be sent to each reader. These levels remain constant regardless of input level fluctuations.

9.4. SELECTING THE PROPER RISE TIME

Rise time limiting was specified in SMPTE and EBU to minimize crosstalk from time code into audio. A longer rise time removes more high frequency components from its waveform. However some equipment may not be able to read time code if its rise time is too long.

The SR-112 has three preset rise times for its output waveform: 1µsec, 20 µsec and 40µsec. The first one is a square wave, the third is per SMPTE and EBU specs and the second is an intermediate value.

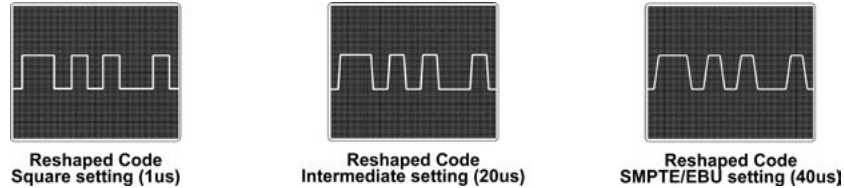

As a general rule, if time code is patched directly into a reader, use the square wave position; but, whenever possible cross-talk problems exist (i.e. in an audio patchbay...) or when recording the reshaped signal, use the SMPTE/EBU setting.

10. Time Code Analyzer

The Analyzer section has 3 main functions:

- to identify the format and frame rate of the incoming time code;
- to verify the proper synchronization (phase) with video;
- to detect and report time code errors

10.1. TIME CODE FORMAT AND FRAME RATE

The LCD display indicates the format and the frame rate (or frequency) of the incoming code. For example: 30DF @ 29.970f/s.



Format vs. Frame Rate

It is important to understand that format and frame rate are not always the same.

- The frame rate, in this case, is a frequency. If the speed varies, the frame rate varies. For example, if a machine was running 5% too fast, a format of 24 fr/sec would have a frame rate of 25.20 fr/sec.
- The format on the other hand does not deal with frequency and stays the same, regardless of the speed. It is a way of counting.

There are 3 time code formats:

- at 30 fr/sec, the frame sequence is: 28, 29, 00, 01, etc...
- at 25 fr/sec, the frame sequence is: 23, 24, 00, 01, etc...
- at 24 fr/sec, the frame sequence is: 22, 23, 00, 01, etc...

29.97 vs. Drop Frame

In addition there is a format variation called Drop Frame used with 30f/s code, which is not to be confused with 29.97. 29.97 indicates a rate (frequency) and drop-frame indicates a format (count).

When generating 29.97 time code, the generator locks to a field rate of 59.94 Hz (NTSC color rate) and pulls down the frame rate by .1% to 29.97. But the format or frame count remains 30 fr/sec.

Drop Frame was invented to compensate for that color rate of 29.97. Drop Frame code (DF) leaves certain frame numbers out so that one hour of code time equals one hour of stopwatch time when code is running at 29.97.

In practice, drop and non-drop code can both be generated at a rate of 30 or 29.97 fr/ sec. For that reason, the frame rate and the drop frame status are displayed separately

10.2. VIDEO PHASE

For time code to be synchronous with video, each word of time code must line up exactly with the video frame it describes. This is essential for video editing.

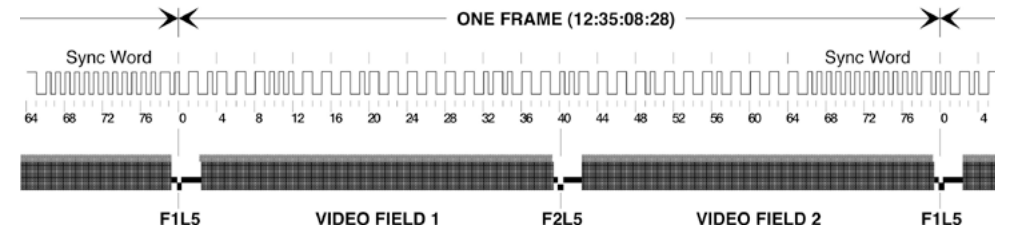

Per SMPTE specifications, the first transition of bit 0 of the codeword must occur at the reference point of the video frame with which it is associated. This video reference point is defined differently depending on the system:

- In analog television systems, it is the start of the vertical sync;
- In digital television systems, it is the start of the video frame;
- In 525/59.95 systems, it is the start of line 4;
- In all other systems, it is the start of line 1.

For digital television systems with rates up to 50 or 60 Hz, see 10.3 below.

Video Phase Display

To monitor the sync between time code and video go to the "Video Phase" page on the LCD display by tapping the [UP] or [DOWN] key.



With synchronous code, the display should read: "000.0°". In the real world however, things are different and phase will often be slightly off. So long as you are within a few degrees and that number remains constant, you should have no problems.

Video Phase LED

The Video Phase LED lights up to indicate that time code is out of phase with video, which means that time code is running at the right speed and is resolved properly but that there is an offset between the two signals.

By default, the SR-112 considers time code in phase with video if the phase is within + or - 20°. If required, this window can be changed by adjusting the "Out Of Phase Threshold" in menu 07. The range is from 0° to 99° (see page 9).

Video Drift LED & Error Message

The Video Drift LED indicates that time code is not synchronous with video.

When the 'drifting' state is triggered, the Video Drift LED lights up and a new 'DRIFT' error message is displayed on the 7-segment display:



The "drifting" state remains in place until either the input time code (or video) goes away, or an "error clear" is requested (by pressing any key).

By default, the SR-112 considers time code as “drifting” when it’s alignment with video (video phase) has changed by 2.5% or more. If required, this “Drift Threshold” can be changed in menu 08. The range is 0.1% to 9.9% (see page 9).

WARNING: IF THE PHASE CHANGES, TIME CODE IS ASYNCHRONOUS AND MAY BE USELESS FOR YOUR APPLICATION

10.3 PHASE WITH 50 or 60HZ VIDEO

SMPTE time code was developed for analog television operating with rates up to 30 f/s. With digital television, progressive video systems have frame rates up to 50 and 60 f/s. In these systems, counting is done on frame pairs and the video reference point is the start of line 1 of the first frame of the frame pair to which the LTC is associated.

The individual frames should be identified by their timing relative to the LTC with the first frame aligned with LTC bits 0 through 39 and the second frame of the pair aligned with LTC bits 40 through 79.

SR-112: Frame A vs. Frame B

When using 2x video rates (50, 59.94, 60Hz) for checking phase of a timecode input the SR-112 extracts a 1x rate (25, 29.94, 30Hz) from the video, and it does this by arbitrarily discarding every second input video frame edge.

Conceptually the input video frame sequence can be thought of as a sequence of pairs of frames, with the first frame of each pair denoted as “A” and the second as “B”. This is a purely imaginary construct of course, as the frames themselves are indistinguishable one from the other.

When the SR-112 first powers up, if a 2x video rate is selected as its reference, it will initially lock to the “A” frames and discard the “B” frames. This will normally be a satisfactory arrangement, but it is possible that the SR-112 will be using the “A” frames when the user would prefer that the “B” frame edges are followed. For example, when testing timecode input phase against a 2x video rate and getting the result that timecode is always 180 degrees out of phase. In this case the user will want to switch to the alternate video phase via menu 09.

10.4 REPORTING TIME CODE ERRORS

One of the functions of the analyzer is to detect and report time code errors. Errors considered serious enough to cause a problem are labeled “fatal” by the SR-112. Others are “non-fatal”. For a complete list, see appendix C.

All “fatal” errors are reported on the front panel; “fatal” and “non fatal” errors are both reported on the ethernet report.

The 8 digit display:

Every time the SR-112 detects a “fatal” error, the reader is momentarily interrupted and displays a description of the error (i.e. “Drop-out” etc...) for about 2 seconds. Then it returns to its normal mode of operations.



Here is a list of error messages as they are reported on the 8 digit display:

DROP OUT: Drop out - Code interruption for less than 1 second.
 CODESTOP: Code Stopped - Code interruption for 1 second or more.
 REPEAT: Repeated Frame
 DISCONT: Discontinuous Address

INVALID: Invalid Code
 VID-LOST: Video Loss - Any interruption in the video signal.
 TYPE CHG: Code Type or Format Change
 DF CHG: Change in the Drop Frame Status
 CF CHG: Change in the Color Frame status
 DF ERR: Drp Frame error - received a “00” or “01” frame where there should have been a “02”
 RESET: Manual Reset

Beeper:

The beeper sounds when a fatal error is detected. It can be deactivated in menu 06.

Warning LED:

After the SR-112 has detected a “fatal” error, the INPUT ERROR warning LED starts flashing. This way, if you leave the room, you will know if an error occurred while you were away.

To stop the LED from flashing manually, press any key.

The LED also stops flashing when the SR-112 is goes through an automatic reset.

LCD Display:

Press the [UP] or [DOWN] key until the ERROR page appears on the LCD display. To scroll through the different errors, press the [LEFT] or [RIGHT] keys.



For each error detected, an error description appears on the top line and the faulty address appears on the bottom line.

The left/right arrows are only present when there are more errors in that direction. Right = increasing time codes; Left = decreasing.

The display is normally showing the most recent error, but arrowing to the left will hold it at the error being viewed. It will return to displaying the most recent error if the operator either (a) arrows all the way to the right, or (b) switches to a different display and back (e.g. to the TC In Status display, or to a Menu).

10.5 POWER UP ERROR BLACKOUT

All error reporting is inhibited for a 20 second blackout period following power up. Errors are ignored during that time.

10.6 RESET

Reset is achieved 2 different ways: Automatically or manually.

Auto Reset: The SR-112 is reset automatically whenever the time code input reappears after an interruption of 5 seconds or more.

Manual Reset: A manual Reset is done by pressing and holding the [SET UP] button for 3 seconds or more. The 8 digit display will confirm this by indicating “- RESET -”.

The following occurs after a reset:

- All LED’s stop flashing
- A new START TIME is established and a new time code report started
- The error register is cleared
- The Drift detector is reset

11. Non-Volatile Storage

The SR-112 has non-volatile memory holding the current settings. This includes Mode, Beeper Setting, Output Rise Time, Output Levels, Video Phase Threshold and Video Drift Threshold. This memory is continuously updated so that, when the unit is turned on, it is in the same condition as it was when powered down.

NOTE: You should wait approximately 10 seconds after a change was entered before powering down, to allow for the flash memory to be updated.

12. Ethernet

The Ethernet port is used to connect the SR-112 via standard TCP/IP protocol. It enables the user to access the SR-112 remotely, and to upload firmware from any computer on the network, including mobile devices such as tablets or smartphones.

The first thing you need is to set its IP address properly using the front panel keys.

12.1. ETHERNET IP SETTINGS

Menu 91 lets you activate DHCP. With DHCP on, the server assigns an IP address to the SR-112 automatically along with a subnet mask and a gateway.



Menus 92, 93 and 94 then become status menus, indicating the IP Address, Mask and Gateway but not allowing you to change them.

If DHCP is off, then the IP address, mask and gateway must be entered manually in menus 92, 93 and 94.



12.2. MAIN HTML PAGE

With the IP settings properly entered, point any browser (Firefox, Explorer...) to your SR-112's IP address to access its main HTML page.

Header

The page's header includes the Serial Number, the IP Address and the Firmware. This information comes from the unit and cannot be edited here.

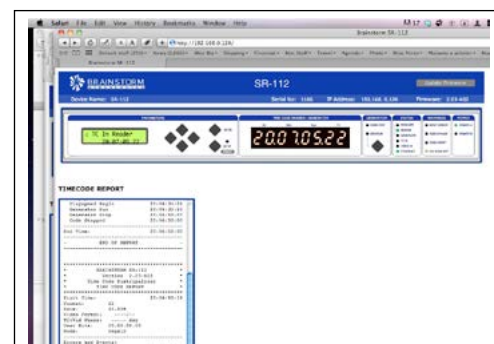

Also included is the Device Name which can be edited. To change it, click on the name area and a text box will open up. Type in a new name (up to 32 characters) and hit Enter. Or hit Esc to get out without any change.

In the upper right corner is the UPDATE FIRMWARE button. Clicking this takes you to a separate specialized page. See chapter 13.

Front Panel Replica

The main section of the HTML page is a functional replica of the front panel.



The front panel switches and web page buttons operate in parallel, although web page clicks are inhibited while any front panel key is being pressed. Status pages can be selected by using the [UP] and [DOWN] buttons; Menus can be accessed by clicking on the [SET UP] button...

A RESET button has been added to the right of the SET UP button. Clicking on RESET is the equivalent of holding the [SET UP] switch on the front panel (see 10.5). A popup window asks for confirmation before proceeding.

The displays and LED's are refreshed every second, plus immediately after any button on the page is clicked. The frames digits on the 7-segment display will blank while timecode is in motion but the seconds digits will be updated more or less in real time since the page is refreshed every second.

Time Code Report

A Time Code report is automatically generated in RESHAPE and REPAIR modes as soon as the SR-112 receives valid time code. The report ends when time code is interrupted for 5 seconds.

Reporting is disabled in GENERATE mode.

The report header includes the start time, the Time Code format and rate, the video format and the TC/Vid phase (if video is present), the User Bits and the SR-112 operating mode.

The current date is inserted at top of report. It is also inserted into the report at reader 24-hour crossing.

Errors are listed as soon as they are detected with the corresponding time code address. For a complete list of error messages, see Appendix C.

Below the report box are two buttons:

- PRINT REPORT: launches a popup containing the complete report text, together with a standard Print command window. Note that text within the report window can also be selected, then copied and pasted it into any text file.

- CLEAR REPORT: clears all text in the Time Code Report box. A pop up window asks for confirmation before proceeding.

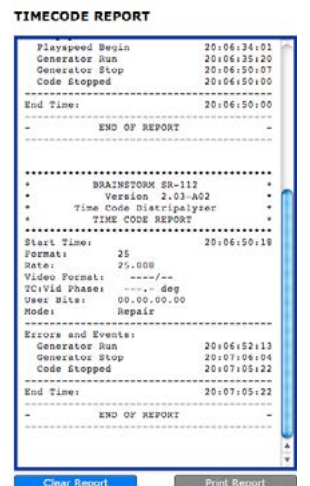

13. Firmware Updates

13.1. FIRMWARE UPDATE PAGE

Clicking on the UPDATE FIRMWARE button of the main HTML page takes you to another page, strictly dedicated to uploading new firmware.



To update your firmware, click on the BROWSE button and select the firmware file on your hard disk (.upld). Then click UPLOAD. The normal programming sequence will follow.

Messages in the Upload Status box at the bottom of the page keep you informed of the progress (see programming sequence below), including error messages.

13.2. COMPLETE VS SOFTWARE

When downloading firmware updates from the Brainstorm website, 2 types of image files are available: complete and software.

The SR-112 FLASH memory is divided in several sections, for the parameters settings, the application software, the Loader software and the FPGA image. The diagram below shows the difference between 'complete' and 'software' updates.

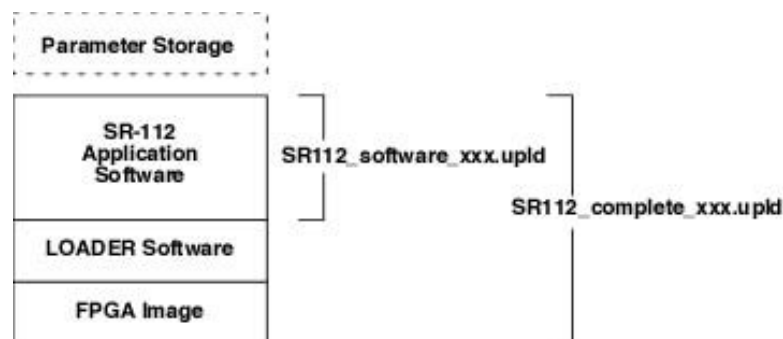

The major software rev number will change whenever the FPGA or LOADER changes. This means that:

- updates between any 3.xx version can be 'software' only,
- updates from, for example, 3.xx to 4.xx must be a "complete" update.

13.3 PROGRAMMING SEQUENCE

There are 3 steps in the normal programming sequence:

- UPLOAD
- VERIFY
- PROGRAM

During this sequence, the 7-Segment display shows all dashes (with regular software also showing the time code decimal points – not so with the Loader), and the LCD sequences through the following displays:

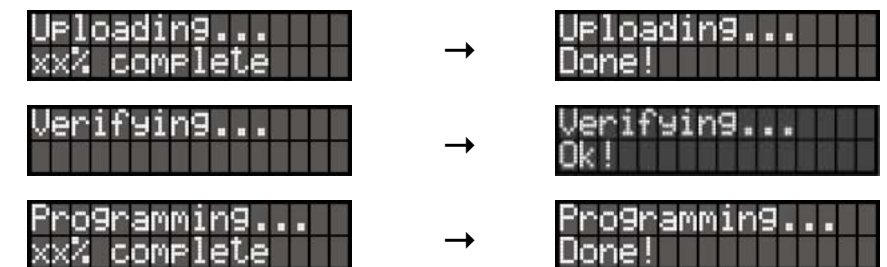

Note: During the 3rd step (programming), Ethernet is internally disconnected.

Reboot

- At the conclusion of a Flash programming sequence following the upload of a "complete" image file, the display shows that a manual reboot is required.

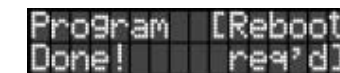

- With a 'software' image file, the SR-112 automatically reboots.

13.4 PROGRAMMING ERRORS

If an error occurs during the programming sequence, possibly due to a network error, a power failure or a pulled cable, one of 3 error messages appears in the LCD display.



'Upload Error' is not very serious since the error was detected before the start of programming. Simply press any key and start again.



'Flash Error' is most likely similar to the previous error. Press any key and start again. However, if the same message reappears right after, it means the corruption occurred after programming had begun and the Loader procedure should be used.



'Program Error' indicates that an error occurred during the programming step and the consequences will depend on the type of update:

- SOFTWARE UPDATE: The Application Software may have become corrupted but the Loader is intact and can be used to restore the SR-112 (see 13.5).
- COMPLETE UPDATE: A Programming error during a 'complete' update is most likely not recoverable via Ethernet and your SR-112 will need to be returned to the factory for a full restore of its flash memory.

IMPORTANT:

IF A PROGRAMMING ERROR OCCURED DURING A 'COMPLETE' UPDATE AND THE UNIT IS STILL ON, TRY RUNNING THE PROGRAMMING SEQUENCE AGAIN AS DESCRIBED IN 13.3, WITHOUT CYCLING POWER.

IF POWER IS TURNED OFF, THE UNIT WILL MOST LIKELY NEED TO BE RETURNED TO THE FACTORY.

13.5 LOADER

The Loader is a fall-back web page that allows you to restore your SR-112 in case of a programming failure. This page is located in a different area of the Flash Memory (see LOADER SOFTWARE on the Flash Memory map above, 13.2).

To enter the LOADER mode, hold down the [DOWN] and [SETUP] keys while powering up and until "SR-112" appears on the display (you don't have to hold down the power key itself – a single hit is sufficient).

When the Loader is run, prior to any upload and programming activity, the 7-Segment display will show "LoAdEr", and the following message appears in the LCD:



Point your browser to the IP address of your SR-112. The following page will appear

This page is similar to the regular Upload page described above, without active status updates.

To restore your unit, use the BROWSE button to locate the firmware file on your hard disk (.upld) and click UPLOAD. The normal programming sequence described in 13.3 will follow.

From Loader mode you can adjust IP addresses and DHCP mode in the usual way.

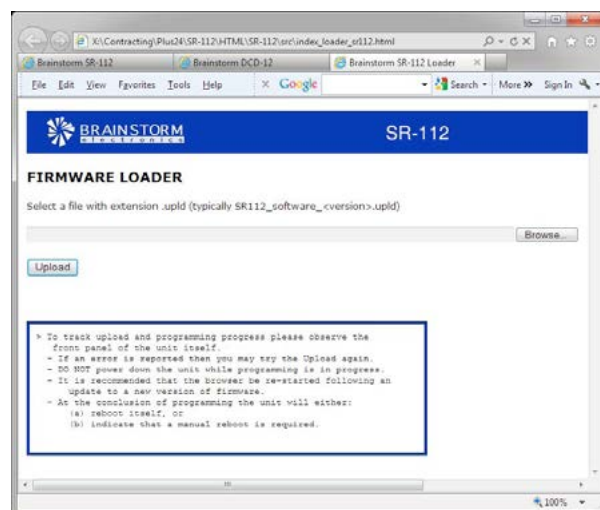

14. User Bits

User Bits (Binary Groups) can be set to carry different information. Three bits (Binary Group Flags) are used to define this: BGFO, BGF1, BGF2 (see Appendix D for SMPTE & EBU bit assignments).

While in the User Bits page (see 5.1), the SR-112 LCD shows the User Bits and the BGF setting.



The table below shows the different options available and how they appear on the display:

Binary Group Flag	Time address	Binary group	Other Doc
0 0 0	"Unsp"	Unspecified	
0 0 1	"8bit"	8-bit codes	ISO/IEC 646 or ISO/IEC 2022
0 1 0	"Clk "	Clock time	
0 1 1	"Rsvd"	Reserved	
1 0 0	"DtTm"	Unspecified	Date and time zone SMPTE 309M
1 0 1	"PgLn"	Unspecified	Page/line SMPTE 262M
1 1 0	"DtTm"	Clock time	Date and time zone SMPTE 309M
1 1 1	"PgLn"	Clock time	Page/line SMPTE 262M

User bits are considered "unavailable" if the input time code is not in forward playspeed mode.

The first 4 characters in each line are derived from the Binary Group Flag bits in the time code stream. The following text from SMPTE 12M-1-2008 has the SR-112 encoding added in:

Binary group flag assignments:

BGF[2:0]	SR-112	Time address reference	Binary group	Other Doc
0 0 0	"Unsp"	Unspecified	Unspecified	
0 0 1	"8bit"	Unspecified	8-bit codes	ISO/IEC 646 or ISO/IEC 2022
0 1 0	"Clk "	Clock time	Unspecified	
0 1 1	"Rsvd"	Reserved	Reserved	
1 0 0	"DtTm"	Unspecified	Date and time zone	SMPTE 309M
1 0 1	"PgLn"	Unspecified	Page/line	SMPTE 262M
1 1 0	"DtTm"	Clock time	Date and time zone	SMPTE 309M
1 1 1	"PgLn"	Clock time	Page/line	SMPTE 262M

When the User Bits are not used, the display will show this:



15. Appendix

APPENDIX A - VIDEO INPUT FORMATS

The following table lists all the video formats recognized by the SR-112 as reference:

525i/29.97 NTSC	1080i/25	1080p/23.976
525i/30	1080i/25 295M	1080p/24
625i/23.976 PAL-	1080i/29.97	1080p/25
625i/24 PAL-	1080i/30	1080p/29.97
625i/25 PAL	1080sF/23.976	1080p/30
	1080sF/24	1080p/50
720p/50	1080sF/25	1080p/50 295M
720p/59.94	1080sF/29.97	1080p/59.94
720p/60	1080sF/30	1080p/60

"PAL-" stands for slow PAL.

Not supported are the low frame rate 720p formats.

APPENDIX B - 25 pin D CONNECTOR WIRING DIAGRAM

The diagram below shows the pin out for the 25 pin D-Sub connector (outputs 1-8):

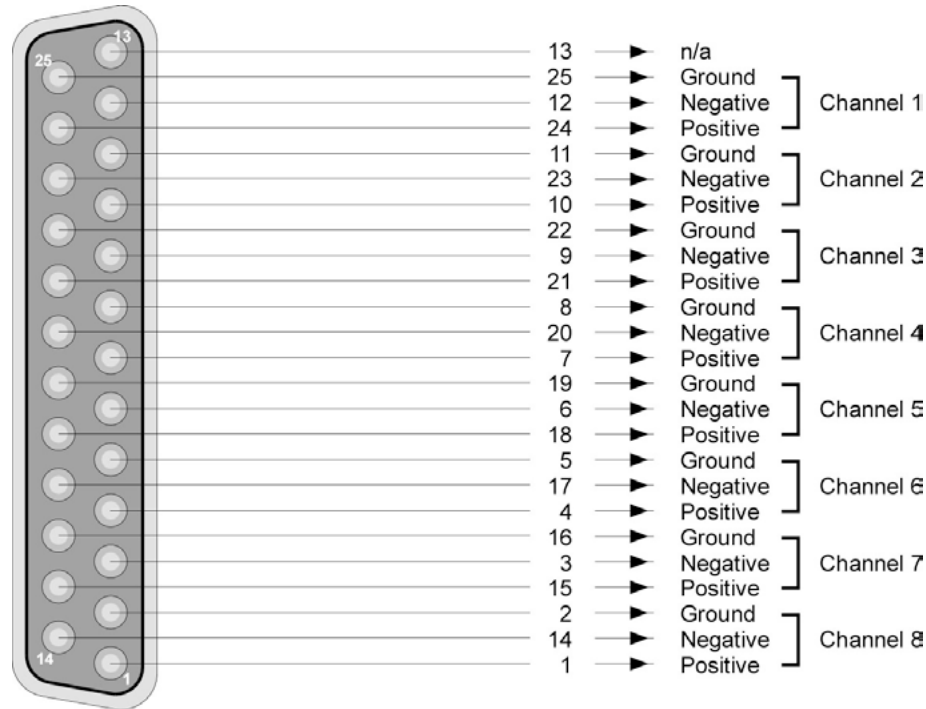

APPENDIX C: TIME CODE ERROR MESSAGES

"Fatal" errors are the ones considered serious enough to cause a synchronization problem. They are reported on the front panel and activate the buzzer; "fatal" and "non fatal" appear on the report, with their corresponding time code address.

FATAL	NON FATAL
Code Drop Out ("DROP OUT") Time code interruption of less than 1 second. Level has to fall below the input threshold of -30dB	Code out of sync If time code slips by more than 2 bits with respect to video "V" drive
Code Stopped ("CODESTOP") Time code interruption of 1 sec. minimum	Change in User Bits status Reported if UB flag changes
Repeated Frame ("REPEAT"): Same frame address detected twice consecutively	Undefined User Status Reported if the binary group flag bits are in undefined combinations
Code Discontinuous ("DISCONT") Any non continuous address (either ascending or descending)	Undefined Bit Set Reported if one of the undefined bits is set (58 - SMPTE & EBU / 10 - EBU)
Invalid Code ("INVALID") Invalid code	User Bit Change Reported if the User Bits message changes If the SR-112 detects that time code was encoded in the user bits, these UB changes are not reported
Video Loss ("VID-LOST") Any interruption in the video signal	Code Restarted When Time Code reappears after a "Code Stopped" message
Code Type Change ("TYPE CHG") Change in the time code type or format	Video Restarted When video reappears after a "Video Loss" message
Drop Frame Change ("DF CHG") Drop Frame flag change	Still Frame A Time Code address is detected consecutively, at least 3 times
Color Frame Change ("CF CHG") Color Frame flag change	Play Speed begins Start time
Bad DF Number ("DF ERR") A "00" or "01" frame was received where there should have been a "02"	Play Speed ends End time
Numeric Error ("CODE ERR") General numeric errors are detected such as 32 fr, 25 hrs...	
Manual Reset ("RESET") Manual reset (see 10.5)	

APPENDIX D: LONGITUDINAL BIT ASSIGNMENT - SMPTE & EBU

Each word of LTC is divided into 80 equal segments (bits), numbered 0 to 79. These bits are mainly grouped by four into Binary Coded Decimal words to form decimal numbers (0 to 9). Twenty six of these bits are assigned to the Time Address information (frames, seconds, minutes and hours); thirty two are assigned to the Binary Group information (user bits); sixteen are used for sync (sync word) and the remaining six are used for flags or are still unassigned.

SMPTE has a frame rate of 30 fr/s and EBU 25 fr/s but both time codes have the same 80 bits per word. Most bits are the same. Some of the flags however are different.

Bit No.	
0	1
1	2
2	4
3	8
4	
5	
6	
7	
8	10
9	20
10	DROP FRAME FLAG
11	COLOR FRAME FLAG
12	
13	
14	
15	
16	1
17	2
18	4
19	8
20	
21	
22	
23	
24	10
25	20
26	40
27	BI-PHASE MARK PHASE CORRECTION BIT
28	
29	
30	
31	
32	1
33	2
34	4
35	8
36	
37	
38	
39	
40	10
41	20
42	40
43	BINARY GROUP FLAG BIT
44	
45	
46	
47	
48	1
49	2
50	4
51	8
52	
53	
54	
55	
56	10
57	20
58	UNASSIGNED ADDRESS BIT 58
59	BINARY GROUP FLAG BIT
60	
61	
62	
63	
64	SYNC WORD - BIT "ZERO"
65	SYNC WORD - BIT "ZERO"
66	SYNC WORD - BIT "ONE"
67	SYNC WORD - BIT "ONE"
68	SYNC WORD - BIT "ONE"
69	SYNC WORD - BIT "ONE"
70	SYNC WORD - BIT "ONE"
71	SYNC WORD - BIT "ONE"
72	SYNC WORD - BIT "ONE"
73	SYNC WORD - BIT "ONE"
74	SYNC WORD - BIT "ONE"
75	SYNC WORD - BIT "ONE"
76	SYNC WORD - BIT "ONE"
77	SYNC WORD - BIT "ONE"
78	SYNC WORD - BIT "ZERO"
79	SYNC WORD - BIT "ONE"

Bit No.	
0	1
1	2
2	4
3	8
4	
5	
6	
7	
8	10
9	20
10	UNASSIGNED ADDRESS BIT 10
11	COLOR FRAME FLAG
12	
13	
14	
15	
16	1
17	2
18	4
19	8
20	
21	
22	
23	
24	10
25	20
26	40
27	BINARY GROUP FLAG BIT
28	
29	
30	
31	
32	1
33	2
34	4
35	8
36	
37	
38	
39	
40	10
41	20
42	40
43	BINARY GROUP FLAG BIT
44	
45	
46	
47	
48	1
49	2
50	4
51	8
52	
53	
54	
55	
56	10
57	20
58	UNASSIGNED ADDRESS BIT 58
59	BI-PHASE MARK PHASE CORRECTION BIT
60	
61	
62	
63	
64	SYNC WORD - BIT "ZERO"
65	SYNC WORD - BIT "ZERO"
66	SYNC WORD - BIT "ONE"
67	SYNC WORD - BIT "ONE"
68	SYNC WORD - BIT "ONE"
69	SYNC WORD - BIT "ONE"
70	SYNC WORD - BIT "ONE"
71	SYNC WORD - BIT "ONE"
72	SYNC WORD - BIT "ONE"
73	SYNC WORD - BIT "ONE"
74	SYNC WORD - BIT "ONE"
75	SYNC WORD - BIT "ONE"
76	SYNC WORD - BIT "ONE"
77	SYNC WORD - BIT "ONE"
78	SYNC WORD - BIT "ZERO"
79	SYNC WORD - BIT "ONE"